

Digital Sonar KDS-6000BB

SPECIFICATIONS

Model	KDS-6000BB
Output power (RMS)	11.5 kW
Transducer	DHL-6302-BRD.B / BRD.B/AS
Output frequency	130 to 210 kHz (0.1 kHz step)
Tilt angle	5° to -90° (1° step)
Beam angle	8° to 12°
TD stroke	150 to 380 mm (Recommended value 150 mm)
Display size and type	Any monitor with VGA resolution (Owner supplied)
Basic ranges	10 to 1000 (m), 30 to 3000 (ft), 10 to 600 (fm), 10 to 700 (l.fm) (8 ranges can be set to users choice)
Range units	m, ft, fm, l.fm
Scanning sector angles	Sonar mode 5° step: 5°, 25°, 45°, 85°, 125°, 165°, 205°, 360° 10° step: 10°, 30°, 50°, 90°, 130°, 170°, 210°, 360° 15° step: 15°, 45°, 75°, 105°, 135°, 165°, 225°, 360° 20° step: 20°, 60°, 100°, 140°, 180°, 220°, 260°, 360°
Bottom scan mode	3° step: 3°, 27°, 45°, 63°, 93°, 117°, 147°, 177° 5° step: 5°, 25°, 45°, 65°, 95°, 115°, 145°, 175°
360° Scanning time (extracts)	Scanning range (m) 20 40 60 80 100 120 160 180 200 240 400 Scanning time (sec.) (3° step) 6.3 8 10 11.8 14 15.8 19.5 21.6 23.5 27.5 43.3 Scanning time (sec.) (15° step) 3.7 4.7 5.6 6.5 7.6 8.6 10.6 11.5 12.3 14.4 22.4 Scanning time (sec.) (20° step) 3.3 3.7 4.3 4.9 5.7 6.4 7.9 8.2 8.9 10.3 15.7 Scanning time (sec.) (30° step) 3.3 3.4 3.8 4.2 4.8 5.2 6.4 6.6 7.3 8.1 12.2
Bearing center	1° step
Presentation modes	Sonar, Off-center, Bottom scan, Echo sounder, 2 Mode Display, One line
Off-Center	Fore, Back, Left, Right
Target lock	Reverse, Horizontal, Horizontal + Vertical, Marker + Horizontal, Marker + Horizontal + Vertical
Presentation colors	8 colors, 16 colors
Functions	TVG, Color rejection, Dynamic range, Compass display, Pulse width, Output power control, Noise reduction, A-scope, CM key, Frequency bandwidth, Image correction, Bearing display, TD auto up, Sona-Tone™
Language	English, Japanese, Korean, Spanish, Thai, Traditional Chines, Greek, Italian, Portuguese, Burmese
Input data format and sentences	NMEA0183 GGA, GLL, HDG, HDM, HDT, RMC, THS, VTG, ZDA
Output data format and sentences	NMEA0183 DBT, DPT, GGA, GLL, MTW, RMC, TLL, VTG, ZDA
NMEA ports	Total 1: input / output
Power supply Processor unit	10.8 to 31.2 VDC
Power supply Hull unit	10.8 to 31.2 VDC
Power consumption Processor unit	70 W or less (24 VDC)
Power consumption Hull unit	70 W or less (24 VDC)
Operating temperature	-15 °C to +55 °C
Water protection	-

CONNECTIONS

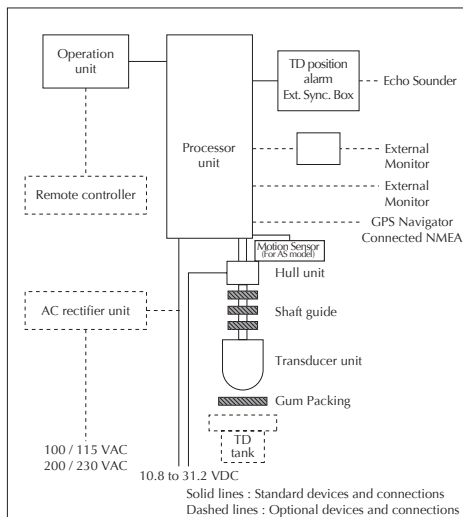

EQUIPMENT LIST

Standard equipment	Processor unit	1
	Operation unit	1
	Hull unit (Normal stroke / Short stroke)	1
	Accessories for Processor unit	1
	Installation materials for Hull unit	1
	TD position alarm / Ext. Sync. Box	1
	DC power cable	1
	Operation manual, Installation manual, Quick Reference	1
Options	Remote controller, PVC TD tank, FRP TD tank, Shaft guide for FRP tank AC rectifier unit, Connecting cable, 17/19 inch LCD monitor	

DIMENSIONS AND WEIGHT

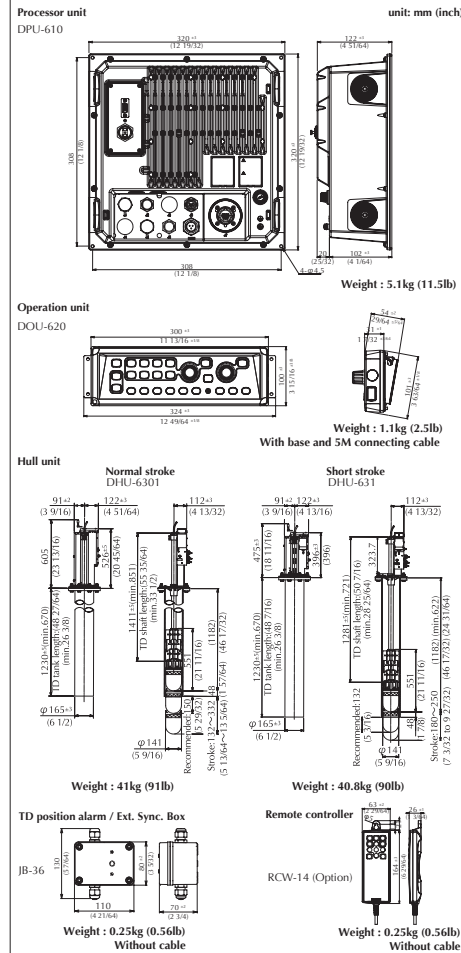

* Design and specifications are subject to change without notice.

KODEN Kodens Electronics Co., Ltd.

Tamagawa Office:
2-13-24 Tamagawa, Ota-ku, Tokyo, 146-0095 Japan
Tel: +81-3-3756-6501 Fax: +81-3-3756-6509
Uenohara Office:
5278 Uenohara, Uenohara-shi, Yamanashi, 409-0112 Japan
Tel: +81-554-20-5860 Fax: +81-554-20-5875
overseas@koden-electronics.co.jp
www.koden-electronics.co.jp

Agenzia
ufficiale per
l'Italia:

Apelmar

Telefono 010 870058 r.a.
Telefax 010 870248
apelmar@koden.it
www.koden.it

Safety precaution To ensure proper and safe use of the equipment, please carefully read and follow the instructions in the Operation Manual.

For details, please contact:

«Broadband»

**World first Broadband searchlight sonar
Added motion sensor function
and newly added short stroke model.**

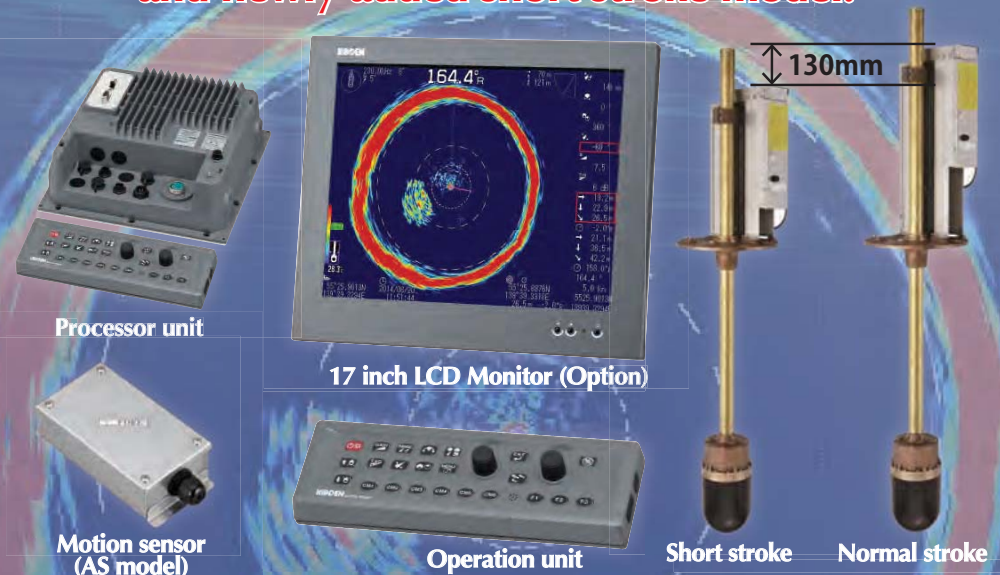

Features

- Change frequency on the go with our advanced Broadband Technology
- Massive improvement in scan speed, making detection of fish schools much faster
- Clearest possible images with our digital signal processing
- All setup and user settings changed instantly by utilizing Conditional Memory function
- Black Box sonar with 17/ 19 inch LCD Monitor available (Option)
- Short stroke Hull unit available for small space
- The stabilizer function reduces the disturbance of sonar display caused by the pitch and roll of the vessel (For AS model)

Digital Sonar

KDS-6000BB

● Advanced Broadband Technology

KDS-6000BB is world first Broadband searchlight sonar. With the broadband transducer equipped as standard, the most suitable output frequency can be selected in 0.1 kHz step depending on the fishing method and the target species from closer range to longer range. Selection of frequency is as easy and quick as tuning a radio. Flexible frequency selection enables user to tune outside of other vessel interference frequency, providing much cleaner image.

● Clearest possible images with our digital signal processing

Both of high resolution in closer range and noise reduction performance in longer range are materialized at high level with newly-developed digital signal processing, KDP V.

● Massive improvement in scan speed

Scanning speed is remarkably increased by adding 15° and 20° in scanning sector angle steps. It can detect surrounding fish schools quickly.

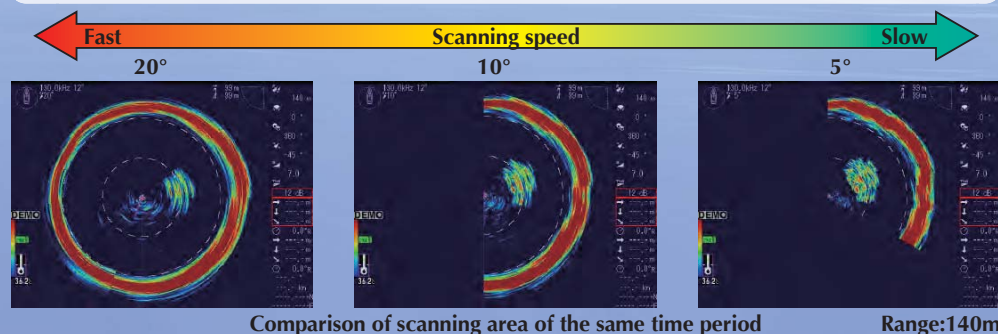

● Six different presentation modes

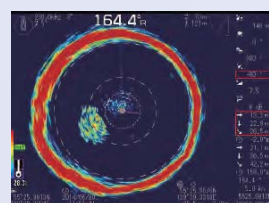

Sonar mode
Search around the ship

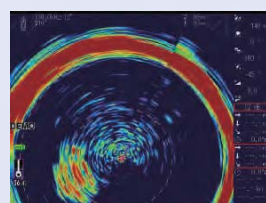

Off-center mode
Show more information of ahead

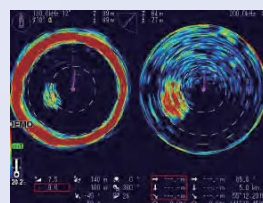

Sonar x 2 mode
Two different frequencies

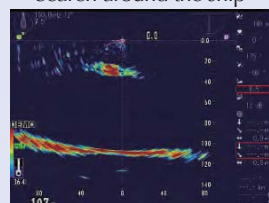

Bottom scan mode
Reflected echo from underwater and sea bottom

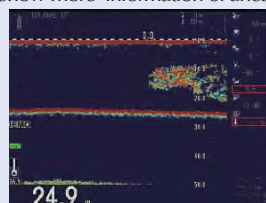

Echo sounder mode
Image like Echo sounder

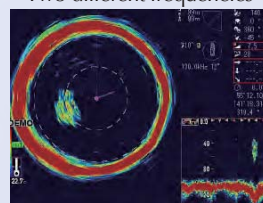

One line display mode
Show vertical Sonar image like an echo sounder image in the Sub-screen

● CM keys



Six of CM keys

Six of CM (Condition Memory) keys offer the user to preset all the current settings and recall them instantly. It is like six sonars in one unit.

● Black box type



KDS-6000BB comes in black box. The user can select a monitor from the market or the optional 17 / 19 inch LCD monitor

● Space-saving Hull unit

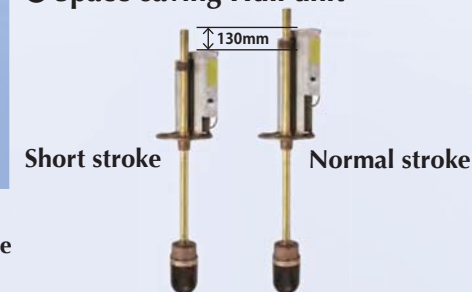

Short stroke Hull unit available for small space

● Motion sensor



The stabilizer function reduces the disturbance of sonar display caused by the pitch and roll of the vessel. (For AS model)

● Example of image

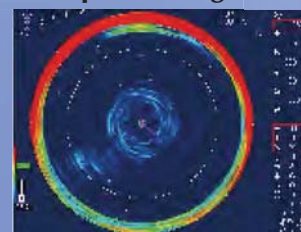

Spear squids at the sea bottom at 130.4 kHz

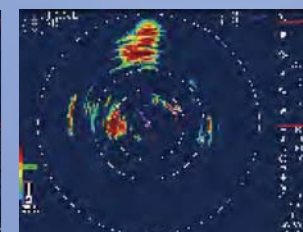

Tunas attacking school of sardines at 140.0 kHz

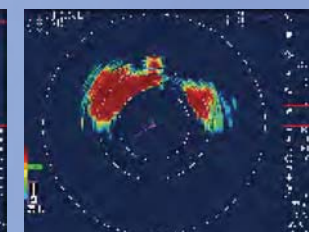

Pilchars at 140.0 kHz