

ONWA[®]

MARINE ELECTRONICS

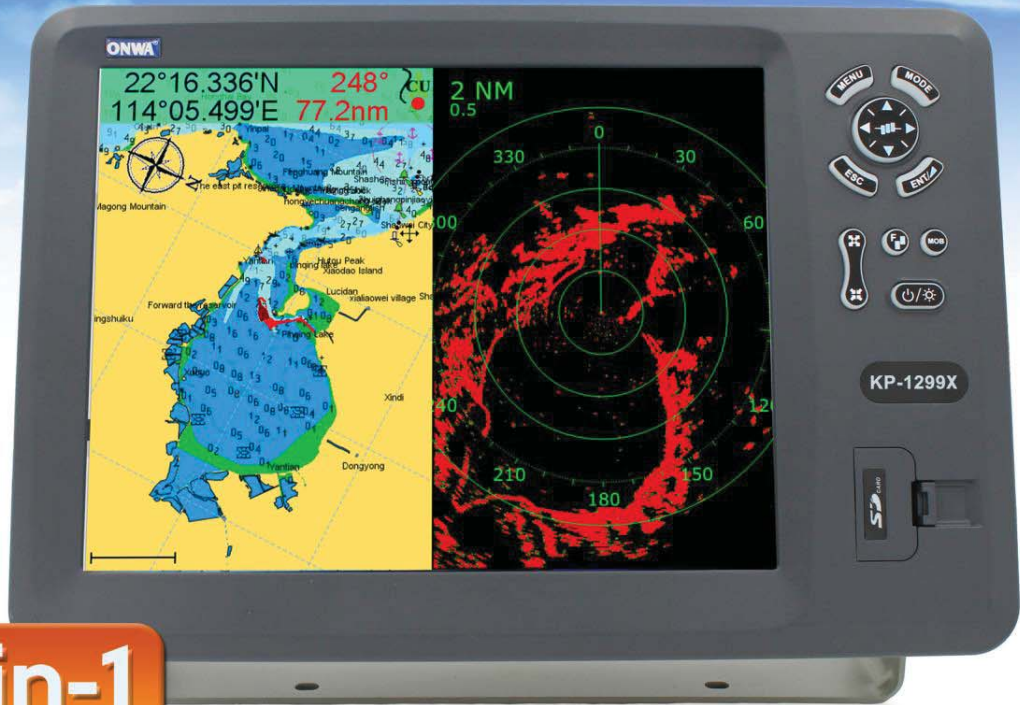

5-in-1

MODEL

KP-1299X

12-inch GPS Chart Plotter with Fish Finder, AIS Transponder, and Radar Function

CLASSB+

Built-in AIS Transponder



K-CHART

Free detailed sea map

C-MAP[®]

Support C-Map MAX

NAVIONICS[®]
A Garmin Brand

Compatible with Navionics+



Built-in Radar Function



SD Card System Update



Built-in Fish Finder

➤ DIFFERENT DISPLAY MODES



Plotter

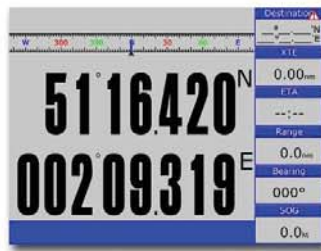

Navigation Data



Compass

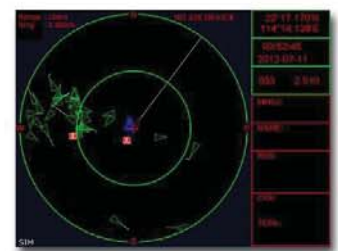

AIS

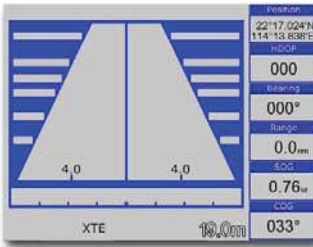

Highway

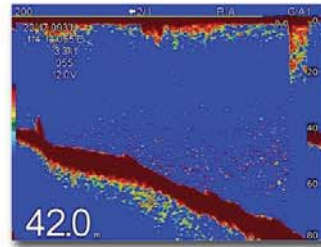

Sounder

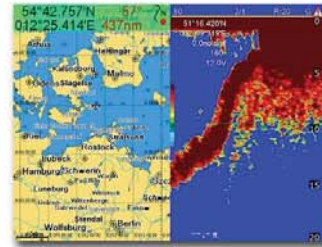

Plotter + Sounder

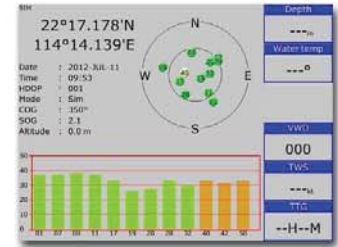

Satellite

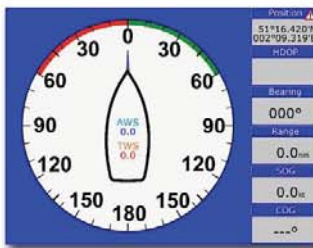

Wind

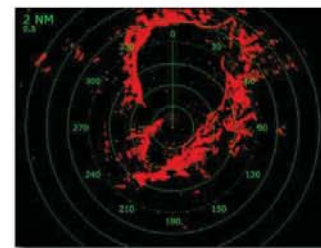

Radar

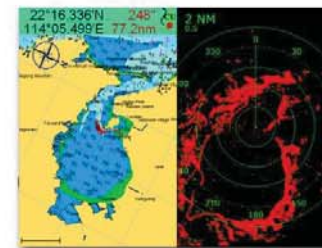

Plotter + Radar
Split Screen

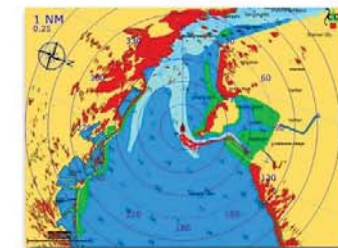

Radar Overlay

➤ GPS CHART PLOTTER

Compatible with the following mapping systems:

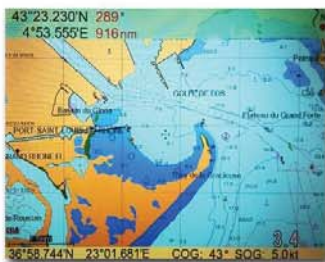

K-Chart Mapping System

ONWA Chart Plotters are compatible with K-Chart Mapping and displays worldwide Electronic Charts that users can use for FREE



C-Map Max

ONWA Chart Plotters are also compatible with C-Map Max showing Nautical Charts



Navionics+

ONWA Chart Plotters when used with Navionics+ charts shows Nautical Charts and Sonar Charts. Advance options also include: Highlight Shallow Area, Adjust Contour Density and Shallow Fishing Range

Standard
Accessory



KA-07
External GPS Antenna
with 10m cable

➤ BUILT-IN HD FISH FINDER TECHNOLOGY

*Transducer required

- Applies the most advanced Digital Fish Finder Technology
- Dual Frequency: 50 and 200kHz (alternately transmitted)
- Automatic Range and Gain adjustment depending on usage (Cruising or Fishing)

- > Excellent Sea-bed Discrimination and easily identify fishes and school of fish
- > Exact depth to where the school of fish is shown for ease of fishing

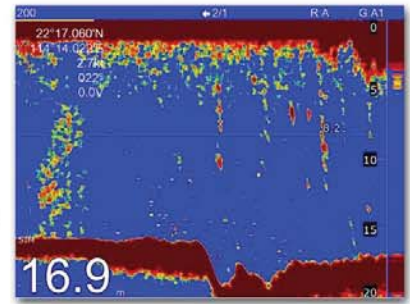

➤ DISPLAY MODES

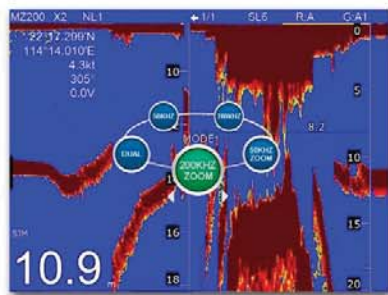

DISPLAY MODES

- > Selection of Display Modes depending on your need
- 50 KHz, 200KHz, Dual, 50KHz/Zoom and 200KHz/Zoom**

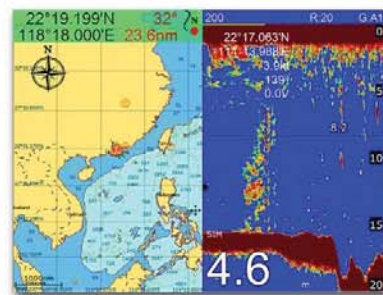

Split Screen with GPS Chart Plotter

- > Split Ratio can be adjusted as to which side is bigger for ease of usage
- > Beneficial for users to mark new fishing grounds

➤ FEATURES

16 Colors according to intensity

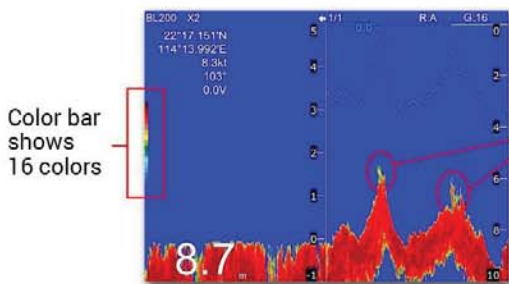

Color bar shows 16 colors

Can distinguish different strength of echoes by colors

Saves the position of a History Echo in Waypoint Memory

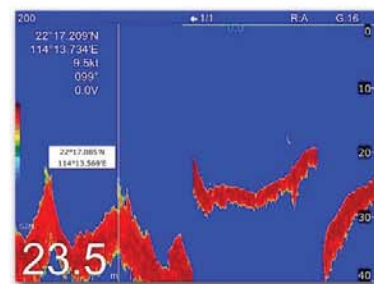

➤ FISH, BOTTOM, AND TEMPERATURE ALARMS

*Temperature sensor required for Temperature Alarm

- Fish Alarm:** Alarms when fish is seen at set range
- Bottom Alarm:** Alarms when the set bottom range is reached

- Temperature Alarm:** Used to warn the user when temperature reaches set temperature range

OPTIONAL ACCESSORIES

(not included in the standard set)



KTD-520_TM
Transom Mount Transducer 600W



KM-Sonar
Fish Finder Black box



Bronze Transducer
Thru-hull Transducer 600W



Plastic Transducer
Thru-hull Transducer 600W



KTS-10K_TM
Transom Mount Temperature Probe



KTS-10K_TH
Thru-Hull Temperature Probe

▶ AIS FEATURES

*VHF Antenna required



Class B+ AIS Technology

- **SOTDMA Technology** - Same technology used by Class A
- **5W Transmission Power** - Guaranteed time slot allocation
- **Increased Transmission Rate (Based on speed)** - increases the range and AIS Satellite reception enabling Global tracking

AIS Messaging



- Can send and receive composed messages between ONWA AIS plotters
- Messages can be Broadcasted or can be sent to a specific MMSI no.
- Message History and number of Unread messages can be viewed when a contact is selected
- Pop-up Box for Incoming Message Alert

NOTE: Contacts Shown are compatible ONWA AIS plotters with AIS Messaging Capability only



Chat Sample

(Speaker icon shown when sent message is sent via Broadcast)



Chat History

can be viewed once specific MMSI is selected

exactTrax™

exactTrax Tracking

- > Integrated with exactTrax AIS satellite tracking technology service which provides the ability to track fishing boats and small commercial vessels with AIS Class B type transceivers across the globe

NOTE: In order to use exactTrax, user must avail ExactEarth Service



ExactTrax showing position of a vessel sailing for 1 week from Hong kong to Malaysia in multi-hour vessel track

AIS Target Tracking

ONWA AIS Plotters now has the ability to record tracks of AIS Targets

> **Manual AIS saved tracks:** Record Manually selected AIS targets, Max = 10 targets/records



- Recorded tracks can be saved as a route



Points in the track shows the location, date, time, SOG and COG, etc.



Recorded Track saved as a route

CPA and TCPA Alarm



Alarm that helps the user to be aware of nearby vessels stating possible CPA and TCPA. The unit alarms until acknowledged

Vessel List

No.	NATION	MMSI	NAME	DIST	COG	TYP
000		050000002	HOSH WANG WEI YI	21.8	0.0	NET
001		009102242		0.1	***	B
002		009103057		0.1	0.0	B
003		009010120		0.1	0.0	B
004		009102360		0.2	0.0	B
005		000000083		1.3	0.0	A
006	HONG KONG	477995063		1.4	256.9	A
007	HONG KONG	477995066		1.8	340.1	A
008	BAHAMAS	308768000		1.9	71.1	A
009	HONG KONG	477995065		1.9	204.2	A
010	CHINA	413468840		2.2	101.7	A
011	HONG KONG	477995026		2.7	128.9	A
012	HONG KONG	477995032		2.8	0.0	A
013	HONG KONG	477995028		3.4	257.1	A
014	HONG KONG	477995070		4.1	71.0	A
015	HONG KONG	477995071		4.2	319.7	A
016	HONG KONG	477995126		4.2	175.4	A
017	HONG KONG	477995029		4.3	293.7	A

Shows nearby vessels, distance to your vessel and information. Selecting a target from the list shows the vessels details

AIS Targets Overlay in the Plotter Screen

Targets are overlaid in the Plotter screen and shows nearby AIS, pointing the cursor at one target shows the MMSI number and Location, selecting the target shows the targets ship details

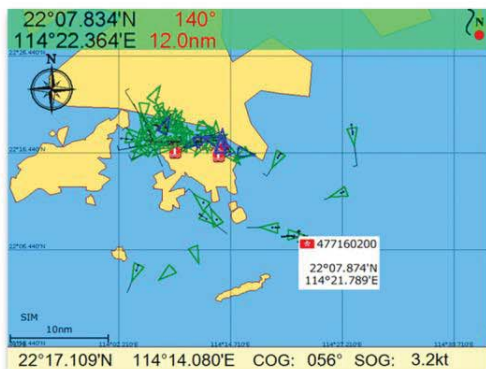

➤ BUILT-IN RADAR FUNCTION

To use **RADAR FUNCTION**, user must avail the Radar Antenna to be connected to KP-1299X

Radar Screens

Screens dedicated for Radar function:

Radar Overlay

- > This added feature overlays radar targets to your plotter's screen to better interpret data
- > AIS targets can also be seen in this mode

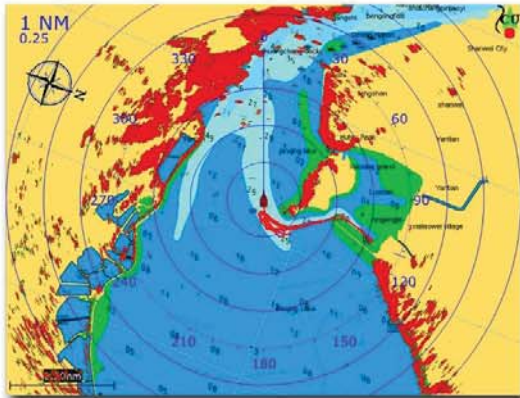

Radar

- > Dedicated radar screen mode for better target interpretation

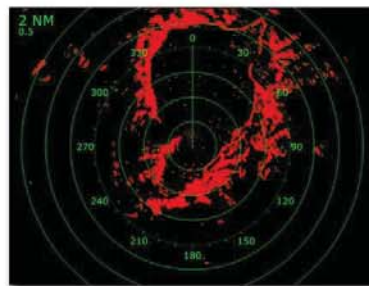

Plotter + Radar Split Screen

- > Split Screen of Plotter and Radar for ease of usage

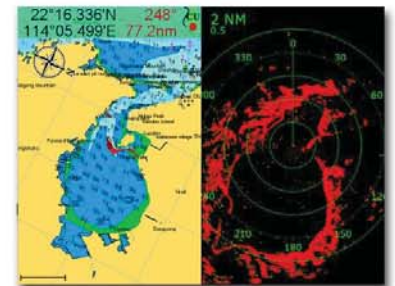

Gain, Sea Clutter and Rain Clutter Adjustment

For better target discrimination



Interference Rejecter



The level of Interference Rejection is shown here

Four levels of Interference Rejection: IR1, IR2, IR3 and OFF for Interference from other shipborne Radar

Echo Stretch

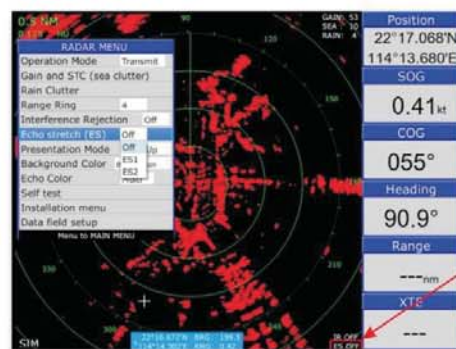

The level of Echo Stretch is shown here

Magnifies Echoes: ES1 (Bearing Direction Only) and ES2 (Bearing and Range Direction)

Echo Colors

For colors depending on the user's preference

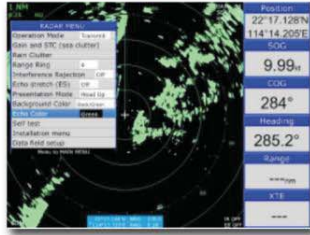

Green

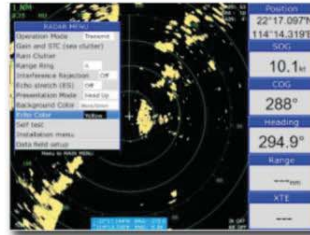

Yellow

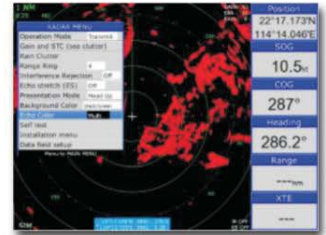

Multi

Self-Test

To check connection between the Display and Antenna and to check TX hours, you can check the Self-Test Status

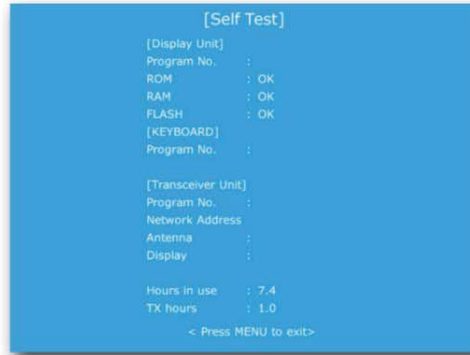

KP-1299X Rear Panel

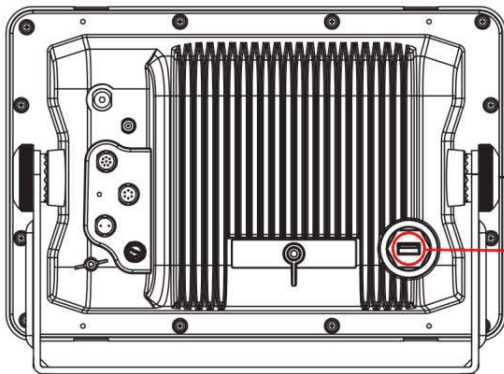

USB Slot for Radar Antenna Connection

Can use any of the following antenna (*Specify when ordering)



Radome Antenna:
KRA-1007_N/KRA-1007W
(Power: 4 kW)



Radome Antenna:
KRA-1009_N
(Power: 4 kW)

RPM depends on range
Short range: 48 RPM
Medium range: 36 RPM
Long range: 24 RPM



Open-Array Antenna:
KRA-4001_N (Power: 6 kW)
KRA-3002_N (Power: 12x.5 kW)
KRA-5002_N (Power: 25kW)

Optional
Accessory



KA-GC9A
Heading Sensor



KM-Router
(For Wi-Fi Radar Antenna (KRA-1007W))
Wi-Fi and Ethernet Router

PLOTTER CHARACTERISTICS

Waypoints/icons	12000 user waypoints with name, symbol 3 system waypoints: MOB, Start , Cursor 10 proximity waypoints
Routes	30 routes waypoint up to 170 points each, plus MOB and Track Navigation or GOTO Track modes
Tracks	8,000 points automatic track log; 10 saved tracks (up to 8000 track points each) lets you retrace your path in both directions
Alarms	XTE, Anchor drag, arrival, speed, voltage, proximity waypoint, Timer and AIS (CPA and TCPA) alarm
Drawing	1000 Drawing Marks; 2000 Drawing Lines (40 points each); 1000 Drawing Place Name; 8 Colors for Drawing
Palette	Normal Daylight exposed to sunlight Night in dark environment NOAA paperchart colors Built-in Worldwide Tide data
Tides	Lat/Lon
Position format	Worldwide
Basemap	Compatible with K-Chart 2.0, K-Chart 3.0, C-Map Max and Navionics+
External Map	Internal backup of user settings or external SD-card
User data storage	5secs to 60 mins or 0.01 to 10nm
Plot Interval	0.001 to 700nm
Plotting scales	700 targets display
AIS	10 Manually saved tracks (300 points each)
AIS Target Tracking	On/off (available for C-Map only)
Perspective View	Sunrise/Sunset Moonrise/Moonset
Celestial	

NMEA SENTENCE SUPPORTED

INPUT: (Auto scan Baudrate)
GGA, GLL, GSA, GSV, RMC, HDG, HDM, HDT
VTG, ZDA, MTW, VWR, VWT, MWD, VPW, VHW
TLL, TTM, VDO, VDM, GNS, MTA
RMA, DBT, DPT, MWV, BWC, XTE, ZDL, WPL, AAM,
APB, BOD, RMB, DSC, MDA, RPM, XDR

OUTPUT:
Baudrate : Selectable 4800, 9600, 19200, 38400
GGA, GLL, RMC, GSA, GSV, AAM, APA
APB, BOD, BWC, BWR, DBT, DPT, HDT
MTW, RMB, TLL, VTG, WPL, XTE, ZDA
ZTG, ZDL, MWD, VPW, VWR, VWT
Outputs for autopilot:
APA, APB, BOD, XTE

AIS INTERFACE

AIS Data: RS232 output VDO, VDM, GGA, GSA, GSV and VTG
AIS Output Baudrate: 38,400

AIS CHARACTERISTICS

Frequency Rate	156.025 MHz~162.025 MHz
Access Scheme	SOTDMA
Channel Bandwidth	25 KHz
Modulation	GMSK
Data Rate	9,600 bps
Number of AIS Transmitter	1
Number of AIS Receiver	2
AIS Channel 1	CH 87B (161.975 MHz)
AIS Channel 2	CH 88B (162.025 MHz)
Tx Power Output	> 5 Watt (37 dBm ± 1.5 dB)
RX Sensitivity	< -123dBm @ 20% PER
RX Message Format	AIS Class A and B messages
Comply Standard	IEC-62287 IEC 62287-2 Ed. 2.0:2017

POWER SUPPLY

10.5 to 30VDC, current drain 1.5A at 12V

PHYSICAL

Size	267.9mm(H) X 363.8mm(W) X 106mm(D)
Weight	2.54 kg
Display	12-inch Color TFT dayview LCD, 800x600 pixels
Waterproofing	Display unit: IPX6 Antenna unit: IPX6
Temperature range	Display unit: -15°C to +55°C Antenna unit: -25°C to +70°C

GPS RECEIVER CHARACTERISTICS

Receiver	50 parallel channel GNSS receiver continuously tracks and uses up to 50 satellites to compute and update your position
Acquisition time	Cold start: 29 seconds Hot start: 1 second
Update rate	1 second
Accuracy	Position: 3 meters(95%) without S/A Velocity: 0.1 meter/sec without S/A
SBAS	Supported
Satellite System	GPS and BeiDou
Dynamics	Altitude: 18,000 m Velocity: 515 m/s
Datum	WGS 84 & user defined
Antenna	KA-07

GPS INTERFACE

GPS Data	RS232 input/output, NMEA 0183 V3.01 and V4.11
GPS Input Baudrate	Auto Scan (4800, 9600, 19200 and 38400)
GPS Output Baudrate	Selectable among 4800, 9600, 19200 and 38400

ECHO SOUNDER

Echo Color	16 colors (including background color) according to echo intensity. The background color is selectable from blue, light blue, white and black.
Basic Range	Meters 5/10/20/40/80/150/200/300/600/1000 Feet 15/30/60/120/200/400/600/1000/2000/3000 Fathoms 3/5/10/20/40/80/100/150/300/600 Up to 1000 meters (3000 feet, 600 fathoms)
Range Shift	Times 2, 3, 4 and 6 ranges
Zoom Range	5/10 meters, 10/20 feet, 2/5 fathoms
Bottom Lock Expansion Range	Automatic adjustment of range and gain
Auto Mode	High Frequency (200K), Low Frequency (50K), Dual (200K and 50K 1/2 display on each), Zoom (200K and 50K zoom) and A-scope Display
Display Mode	Marker Zoom, Bottom Zoom and Bottom-lock Expansion
Zoom Display	Lines/TX: Freeze, 1/8, 1/4, 1/2, 1/1, 2/1, 4/1, 6/1, 8/1 and 10/1
Display Advance Speed	50 and 200kHz (alternately transmitted) 600W (Up to 1kW by using High Power Transducer)
TX Frequency	
Power Output	
Pulse-Length/TX Rate	

Display End Depth (m)	5	10	20	40	80	150	200	300	600	1000
Pulse Length 200K (µs)	120	220	320	520	920	1020	1020	1020	1020	1020
Pulse Length 50K (µs)	170	270	370	570	970	1070	1070	1070	1070	1070
TX Rate (pulse/min)	2000	1333	706	353	171	98	75	53	38	27
TX period (millisecond)	30	45	85	170	350	610	800	1120	1580	2200

Interference Rejecter	Rejects unwanted signals by comparing last and present echoes in strength
Alarm	Fish and Bottom alarms, Temperature alarm (sensor required)

RADAR FUNCTION

Compatible with full range of ONWA Radar Antenna (Supplied as an Option):

Radome Antenna:
KRA-1007_N/
KRA-1007W
(Power: 4 kW)



Radome Antenna:
KRA-1009_N
(Power: 4 kW)



RPM depends on range:
Short range: 48 RPM
Medium range: 36 RPM
Long range: 24 RPM

Open-Array Antenna:
KRA-4001_N (Power: 6 kW)
KRA-3002_N (Power: 12.5 kW)
KRA-5002_N (Power: 25 kW)



EQUIPMENT LIST

Display unit	Mounting Brackets
Quick manual	Standard accessories pack
GPS Antenna (10m)	

USB PORT

Version 2.0
Support: ONWA Radar, KM-sonar, KM-router

OPTIONAL ACCESSORIES

Transom Mount or Thru-Hull Transducer
 Transom Mount or Thru-Hull Temperature Probe
 VHF Antenna (KA-159) (For AIS communication)
 Fish Finder Black Box (KM-Sonar)
 Ultrasonic Weather Station/Anemometer (KW-360)

Radar Antenna (KRA-1007/KRA-1007W, KRA-2006, KRA-3002, KRA-5002)
 Heading Sensor (KA-GC9A)
 N2K (NMEA2000) and NMEA0183 Bidirectional Converter (KC-2W)
 WI-Fi and Ethernet Router (KM-Router) (For WI-Fi Radar Antenna KRA-1007W)



INTERCONNECTION DIAGRAM (KP-1299)

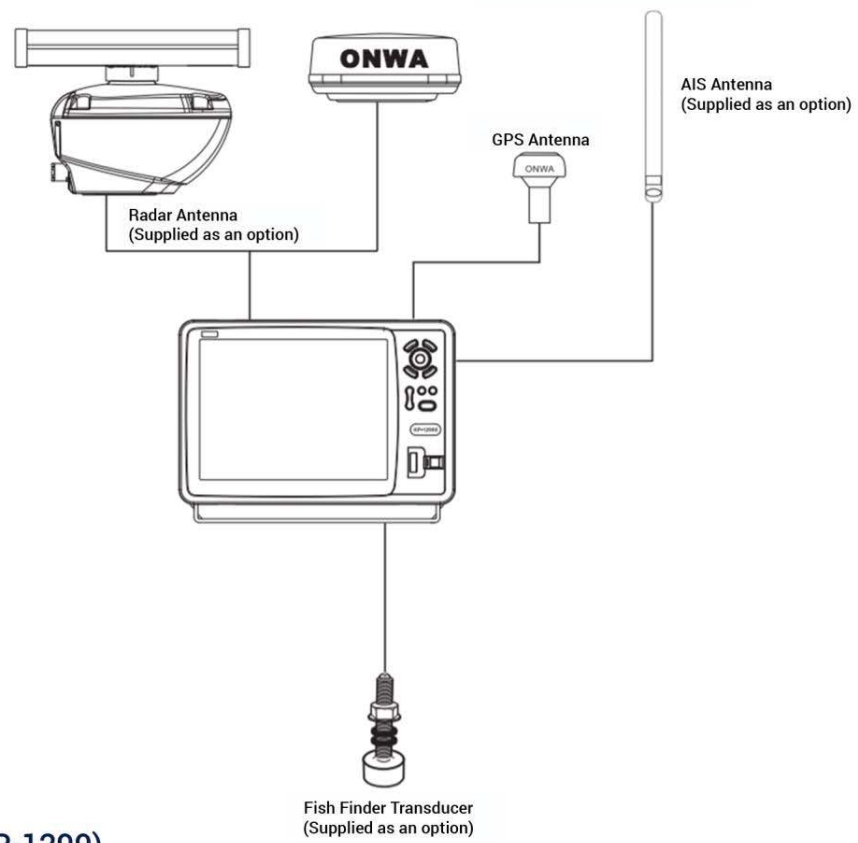

DISPLAY UNIT (DIMENSIONS) (KP-1299)

